

SPIRIT

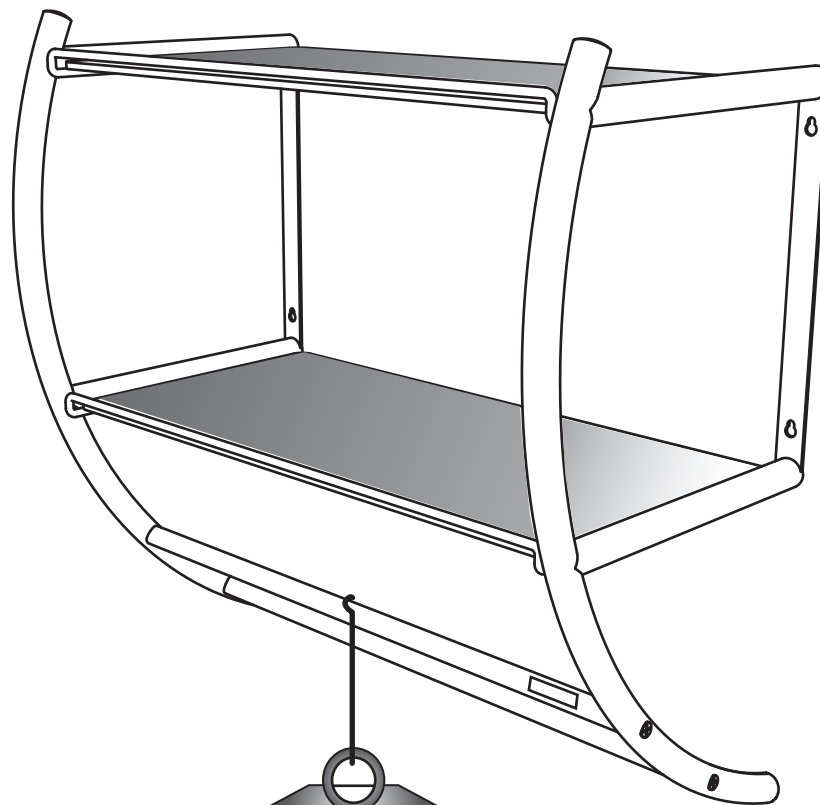
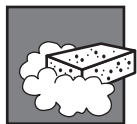

P18207.SP1

F **Entretien - nettoyage**
Employer exclusivement de l'eau savonneuse et une éponge .

GB **Cleaning**
Only use a damp sponge and non-abrasive domestic soap.

D **Reinigung und Pflege**
Verwenden Sie zur Reinigung ausschließlich einen Schwamm und Seifenlauge.

NL **Onderhoud**
Gebruik uitsluitend een lauw sopje en een spons.

I **Pulizia**
Usare esclusivamente dell' acqua con sapone neutro e una spugna.

E **Limpeza**
Emplear solamente agua jabonosa y una esponja.

P **Limpeza**
Utilizar água com sabão e uma esponja, não utilizar produtos abrasivos ou dissolvente.

F **Garantie**
Ce produit est garanti pendant une période de 2 ans à compter de la date d'achat. La garantie couvre les défauts de fabrication constatés lors d'un usage normal, à l'exclusion des pièces soumises à une usure naturelle.

GB **Guarantee**
This product is guaranteed for a period of 2 years from date of purchase. The guarantee covers any product failure which may occur due to manufacturing fault. But specifically excludes any parts subject to normal wear.









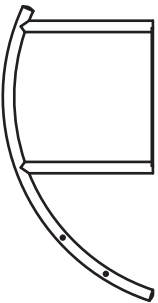

D **Garantie**
Wir geben eine Garantie auf die Dauer von 2 Jahren, beginnend mit dem Datum des Kaufs. Für alle innerhalb der Garantiezeit auftretenden Mängel, die auf Material oder Fabrikationsfehler zurückzuführen sind, wird Ersatz geleistet.

NL **Waarborg**
De produkt heeft vanaf aankoopdatum 2 jaar waarborg. De waarborg dekt fabricagefouten maar kan niet aangewend worden bij slijtage van onderdelen.

I **Garanzia**
Questo prodotto è garantito 2 anni a partire dalla data d'acquisto. La garanzia copre i difetti di fabbricazione accertati durante un uso normale. Sono escluse tutte le parti sottoposte ad usura naturale. E tutto quanto dovesse accadere per un uso improprio o per cadute accidentali.

E **Garantía**
Este producto tiene garantía durante 2 años a partir de la fecha de compra. La garantía cubre los defectos de fabricación observados durante un uso normal, excluyendo las piezas sometidas a un desgaste natural y los deterioros producidos por caídas, golpes o uso indebido.

P **Garantía**
Este produto é garantido durante um período de 2 anos a contar da data da compra. A garantia cobre os defeitos de fabricação constatados durante uma utilização normal, à exceção das peças submetidas a um desgaste natural.

-  **A** x 2
-  **B** x 2
-  **C** x 2
-  **D** x 2
-  **E** x 4
-  **F** x 4
-  **G** x 8
-  **H** x 8
-  **I** x 4
-  **J** x 4

